



# PARTYBOX 100





OWNER'S MANUAL

# IMPORTANT SAFETY INSTRUCTIONS

## For all products:

1. Read these instructions.
2. Keep these instructions.
3. Heed all warnings.
4. Follow all instructions.
5. Do not block any ventilation openings. Install this apparatus in accordance with the manufacturer's instructions.
6. Do not install this apparatus near any heat sources such as radiators, heat registers, stoves or other apparatus (including amplifiers) that produce heat.
7. Do not defeat the safety purpose of the polarized or grounding-type plug. A polarized plug has two blades with one wider than the other. A grounding-type plug has two blades and a third grounding prong. The wide blade or the third prong is provided for your safety. If the provided plug does not fit into your outlet, consult an electrician for replacement of the obsolete outlet.
8. Protect the power cord from being walked on or pinched, particularly at plugs, convenience receptacles and the point where they exit from the apparatus.
9. Use only attachments/accessories specified by the manufacturer.
10. Use only with the cart, stand, tripod, bracket or table specified by the manufacturer or sold with the apparatus. When a cart is used, use caution when moving the cart/apparatus combination to avoid injury from tip-over. 
11. Unplug this apparatus during lightning storms or when unused for long periods of time.
12. To disconnect this apparatus from the AC mains completely, disconnect the power-supply cord plug from the AC receptacle.
13. The mains plug of the power-supply cord shall remain readily operable.
14. Do not expose batteries to excessive heat such as sunshine, fire or the like.
15. This apparatus is intended to be used only with the power supply and/or charging cable provided by the manufacturer.

CAUTION	
<b>RISK OF ELECTRIC SHOCK. DO NOT OPEN.</b>	
	THE LIGHTNING FLASH WITH AN ARROWHEAD SYMBOL, WITHIN AN EQUILATERAL TRIANGLE, IS INTENDED TO ALERT THE USER TO THE PRESENCE OF UNINSULATED "DANGEROUS VOLTAGE" WITHIN THE PRODUCT'S ENCLOSURE THAT MAY BE OF SUFFICIENT MAGNITUDE TO CONSTITUTE A RISK OF ELECTRIC SHOCK TO PERSONS.
	THE EXCLAMATION POINT WITHIN AN EQUILATERAL TRIANGLE IS INTENDED TO ALERT THE USER TO THE PRESENCE OF IMPORTANT OPERATING AND MAINTENANCE (SERVICING) INSTRUCTIONS IN THE LITERATURE ACCOMPANYING THE PRODUCT.
<b>WARNING:</b> TO REDUCE THE RISK OF FIRE OR ELECTRIC SHOCK, DO NOT EXPOSE THIS APPARATUS TO RAIN OR MOISTURE.	

## Caution FCC and IC statement for users (USA and Canada only)

This device complies with part 15 of the FCC Rules. Operation is subject to the following two conditions: (1) This device may not cause harmful interference, and (2) this device must accept any interference received, including interference that may cause undesired operation.

## CAN ICES-3(B)/NMB-3(B)

## Federal Communication Commission Interference Statement

This equipment has been tested and found to comply with the limits for a Class B digital device, pursuant to Part 15 of the FCC Rules. These limits are designed to provide reasonable protection against harmful interference in a residential installation. This equipment generates, uses and can radiate radio frequency energy and, if not installed and used in accordance with the instructions, may cause harmful interference to radio communications. However, there is no guarantee that interference will not occur in a particular installation. If this equipment does cause harmful interference to radio or television reception, which can be determined by turning the equipment off and on, the user is encouraged to try to correct the interference by one or more of the following measures:

- Reorient or relocate the receiving antenna.
- Increase the separation between the equipment and receiver.
- Connect the equipment into an outlet on a circuit different from that to which the receiver is connected.
- Consult the dealer or an experienced radio/TV technician for help.

**Caution:** Changes or modifications not expressly approved by HARMAN could void the user's authority to operate the equipment.

## For Products That Transmit RF Energy

### FCC AND IC INFORMATION FOR USERS

This device complies with Part 15 of the FCC rules and Industry Canada license-exempt RSS standard(s). Operation is subject to the following two conditions: (1) This device may not cause harmful interference; and (2) this device must accept any interference received, including interference that may cause undesired operation.

### FCC/IC Radiation Exposure Statement

This equipment complies with FCC/IC RSS-102 radiation exposure limits set forth for an uncontrolled environment.

### FCC Caution:

High power radars are allocated as primary users of the 5.25 to 5.35 GHz and 5.65 to 5.85 GHz bands. These radar stations can cause interference with and/or damage this device. No configuration controls are provided for this wireless equipment allowing any change in the frequency of operations outside the FCC grant of authorization for US operation according to Part 15.407 of the FCC rules.

### IC Caution:

User should also be advised that:

- (i) The device for operation in the band 5150-5250 MHz is only for indoor use to reduce the potential for harmful interference to

co-channel mobile satellite systems; (ii) the maximum antenna gain permitted for devices in the bands 5250-5350 MHz and 5470-5725 MHz shall comply with the e.i.r.p. Limit; and (iii) The maximum antenna gain permitted for devices in the band 5725-5825 MHz shall comply with the e.i.r.p. Limits specified for point-to-point and non-point-to-point operation as appropriate. (iv) Users should also be advised that high-power radars are allocated as primary users (i.e. priority users) of the bands 5250-5350 MHz and 5650-5850 MHz and that these radars could cause interference and/or damage to LE-LAN devices.

### Exposure of humans to RF fields (RSS-102)

The computers employ low gain integral antennas that do not emit RF field in excess of Health Canada limits for the general population; consult Safety Code 6, obtainable from Health Canada's Website at <http://www.hc-sc.gc.ca/>

The radiated energy from the antennas connected to the wireless adapters conforms to the IC limit of the RF exposure requirement regarding IC RSS-102, Issue 5 clause 4. SAR tests are conducted using recommended operating positions accepted by the FCC/ RSS with the device transmitting at its highest away from the body. Non-compliance with the above restrictions may result in a violation of FCC RF exposure guidelines.

**Use Restriction:** Attention in France, the operation is limited to indoor use within the band 5150-5350 Mhz.

### For Products with Radio Receivers That Can Use an External Antenna (USA ONLY)

#### CATV (Cable TV) or Antenna Grounding

If an outside antenna or cable system is connected to this product, be certain that it is grounded so as to provide some protection against voltage surges and static charges. Section 810 of the National Electrical Code (NEC), ANSI/NFPA No. 700-1984, provides information with respect to proper grounding of the mast and supporting structure, grounding of the lead-in wire to an antenna discharge unit, of grounding conductors, location of antenna discharge unit, connection to grounding electrodes and requirements of the electrode.

#### Note to CATV System Installer

This reminder is provided to call the CATV(cable TV) system installer's attention to article 820-40 of the NEC, which provides guidelines for proper grounding and, in particular, as close to the point of cable entry as possible.

**Caution:** This product uses a laser system. To prevent direct exposure to the laser, do not open the cabinet enclosure or defeat any of the safety mechanisms provided for your protection. Do NOT START INTO THE LASER BEAM. To ensure proper use of this product, please read the owner's manual carefully and retain it for future use. Should the unit require maintenance or repair, please contact your local JBL service. Refer servicing to qualified personnel only.

CLASS 1 LASER PRODUCT  
 KLASSE 1 LASER PRODUKT  
 LUOKAN 1 LASER LAITE  
 KLASS 1 LASER APPARAT  
 CLASSE 1 PRODUIT LASER

## FOR ALL EU COUNTRIES

### For products that include audio out

#### Prevention of hearing loss



**Caution:** Permanent hearing loss may occur if earphones or headphones are used at high volume for prolonged periods of time.

For France, the products have been tested to comply with Sound Pressure Level requirement laid down in the applicable NF EN 50332 L.5232-1.

#### Note:

- To prevent possible hearing damage, do not listen to high volume levels for long periods.

#### WEEE Notice

The Directive on Waste Electrical Equipment (WEEE), which entered into force as European law on 14/02/2014, resulted in a major change in the treatment of electrical equipment at end-of-life.

The purpose of this Directive is, a first priority, the prevention of WEEE, and in addition, to promote the reuse, recycling and other forms of recovery of such wastes as so as to reduce disposal.

The WEEE logo on the product or on its box indicating collection for electrical and electronic equipment consists of the crossed-out wheeled bin, as shown below.



This product must not be disposed of or dumped with your other household waste. You are liable to dispose of all your electronic or electrical waste equipment by relocating over to the specified collection point for recycling of such hazardous waste. Isolated collection and proper recovery of your electronic and electrical waste equipment at the time of disposal will allow us to help conserving natural resources. Moreover, proper recycling, and collection points, please contact your local city center, household waste disposal service, shop from where you purchased the equipment, or manufacturer of the equipment.

#### RoHS Compliance

This product is in compliance with Directive 2011/65/EU of the European Parliament and of the Council of 8 June 2011 on the restriction of the use of certain hazardous substances in electrical and electronic equipment.

### For Products that includes Batteries

#### EU Batteries Directive 2013/56/EU

A new battery directive 2013/56/eu on Battery and Accumulator replacing directive entered into force on the 01/07/2015. The directive applies to all types of batteries and accumulator (AA, AAA, button cells, rechargeable packs) including those incorporated into appliances except for military, medical and power tool applications. The directive sets out rules for collection, treatment, recycling and disposal of batteries, and aims to prohibit certain hazardous substances and to improve environmental performance of batteries and all operators in the supply chain.

## Instructions for Users on Removal, Recycling and Disposal of Batteries

The remove the batteries from your equipment or remote control, reverse the procedure described in the owner's manual for inserting batteries. For products with a built-in battery that lasts for the lifetime of the product, removal may not be possible for the user. In this case, recycling or recovery, it becomes necessary to replace such a battery, this procedure must be performed by authorized services centers. In the European Union and other locations, it is illegal to dispose of any battery with household trash. All batteries must be disposed of in an environmentally sound manner. Contact your local waste-management officials for information regarding the environmentally sound collection, recycling and disposal of used batteries.

**WARNING:** Danger of explosion if battery is incorrectly replaced. To reduce risk of fire or burns, don't disassemble, crush, puncture, short external contact, expose to temperature above 60°C (140°F), or dispose of in fire or water. Replace only with specified batteries. The symbol indicating 'separate collection' for all batteries and accumulators shall be crossed-out wheeled bin shown below:



In case of batteries, accumulators and button cells containing more than 0.0005 mercury, more than 0.002% cadmium or more than 0.004% lead, shall be marked with the chemical symbol for the metal concerned: Hg, Cd or Pb respectively. Please Refer to the below symbol:

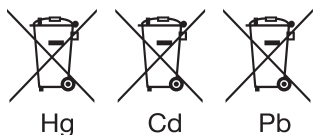

**WARNING:** DO NOT INGEST BATTERIES, CHEMICAL BURN HAZARD [the remote supplied with] This product contains a coin/button cell battery. If the coin/button cell battery is swallowed, it can cause severe internal burns in just 2 hours and can lead to death. Keep new and used batteries away from children. If you think batteries might have been swallowed or placed inside any part of body, seek immediate medical attention.

## For All Products Except Those with Wireless Operation

HARMAN International hereby declares that this equipment is in compliance with EMC 2014/30/EU Directive, LVD 2014/35/EU Directive. The declaration of conformity may be consulted in the support section of our Web Site, accessible from [www.jbl.com](http://www.jbl.com).

## For All Products with Wireless Operation

HARMAN International hereby declares that this equipment is in compliance with the essential requirements and other relevant provisions of Directive 2014/53/EU. The declaration of conformity may be consulted in the support section of our Web Site, accessible from [www.jbl.com](http://www.jbl.com).

## HARMAN

HARMAN International Industries, Incorporated  
8500.255.4545 (USA only)

HARMAN International Industries, Incorporated. All rights reserved. JBL is a trademark of HARMAN International Industries, Incorporated, registered in the United States and/ or other countries. Features, specifications and appearance are subject to change without notice.

# EPILEPSY WARNING

**A few people may experience epileptic seizures when viewing flashing lights.**

## Precautions

### Stand Mounting Safety Precautions

**Always follow instruction and precaution advise from speaker stand manufacturer.**

Partybox 100 contains a 36 mm receptacle cup to allow mounting on tripod stands or on a pole over subwoofers. When using stands or poles, be sure to observe the following precautions:

- Check the stand or pole specification to be certain the device is designed to support the weight of the speaker. Observe all safety precautions specified by the manufacturer.
- Always verify that the stand (or subwoofer/pole) is placed on a flat, level and stable surface and be sure to fully extend the legs of tripod type stands. Position the stand so that the legs do not present a trip hazard.

Use this floor stand only on a flat, solid surface. Once the support (extended leg) has been placed and adjusted, carefully tighten the screws and use the safety pin. After placing the speaker on the stand, check for stability: When tilting each direction to 10 degrees (for the surface), the speaker should not turn off. If necessary, reduce the height of the speakers and extend the base of the stand.

- Route cables so that performers, production crew, and audience will not trip and topple the speakers over.
- Inspect the stand (or pole and associated hardware) before each use and do not use equipment with worn, damaged or missing parts.
- Do not attempt to place more than one PartyBox series speaker on a stand or pole.
- Always be cautious in windy, outdoor conditions. It may be necessary to place additional weight (i.e. sandbags) on the base of the stand to improve stability. Avoid attaching banners or similar items to any part of a speaker system. Such attachments could act as a sail and topple the system.
- Unless you are confident that you can handle the weight of the speaker, ask another person to help you get it onto the tripod stand or pole.

# TABLE OF CONTENTS

---

## **IMPORTANT SAFETY INSTRUCTIONS 2**

FEDERAL COMMUNICATION COMMISSION INTERFERENCE STATEMENT	2
FOR PRODUCTS THAT TRANSMIT RF ENERGY	2
EXPOSURE OF HUMANS TO RF FIELDS (RSS-102)	3
FOR PRODUCTS WITH RADIO RECEIVERS THAT CAN USE AN EXTERNAL ANTENNA (USA ONLY)	3
FOR ALL EU COUNTRIES	3
FOR PRODUCTS THAT INCLUDES BATTERIES	3
FOR ALL PRODUCTS EXCEPT THOSE WITH WIRELESS OPERATION	4
FOR ALL PRODUCTS WITH WIRELESS OPERATION	4
HARMAN	4

---

## **1. INTRODUCTION 6**

---

## **2. WHAT'S IN THE BOX 6**

---

## **3. PRODUCT OVERVIEW 7**

3.1 TOP PANEL	7
3.2 BACK PANEL	7

---

## **4. POWER ON 8**

---

## **5. CHARGING 8**

5.1 CHARGE YOUR SPEAKER	8
5.2 CHECK THE BATTERY LEVEL	8

---

## **6. USING YOUR PARTYBOX 9**

6.1 BLUETOOTH CONNECTION	9
6.2 USB CONNECTION	9
6.3 AUX CONNECTION	9
6.4 MIX SOUND WITH A MICROPHONE OR GUITAR	10
6.5 CHARGING EXTERNAL USB DEVICES	10

---

## **7. CARRYING YOUR PARTYBOX 11**

---

## **8. SETTINGS 11**

8.1 TWS MODE	11
8.2 DEMO MODE	11
8.3 STANDBY MODE	11
8.4 SPEAKER MOUNTING	12

---

## **9. SPECIFICATIONS 12**

---

## **10. TROUBLESHOOTINGS 13**

---

## **11. COMPLIANCE 13**

---

## **12. TRADEMARK 14**

---

## 1. INTRODUCTION

Congratulations on your purchase! This manual includes information about “**JBL PARTYBOX 100**” speaker. We encourage you to take a few minutes to read this manual, which describes the product and includes step-by-step instructions to help you to set up and get started. Read and understand all the safety instructions before using your product.

If you have any questions about these products, their installation or their operation, please contact your retailer or customer service, or visit us at [www.jbl.com](http://www.jbl.com).

---

## 2. WHAT'S IN THE BOX

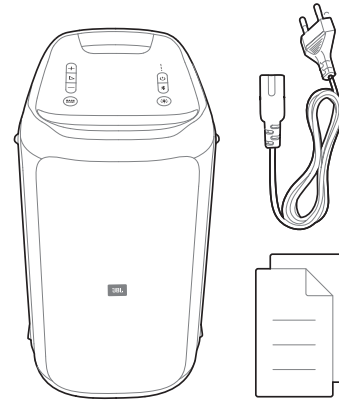

- 1) Main unit
  - 2) Power cord\*
  - 3) Quick Start Guide, Safety sheet, Warranty card
- \*Power cord quantity and plug type vary by regions.

## 3. PRODUCT OVERVIEW

### 3.1 Top Panel

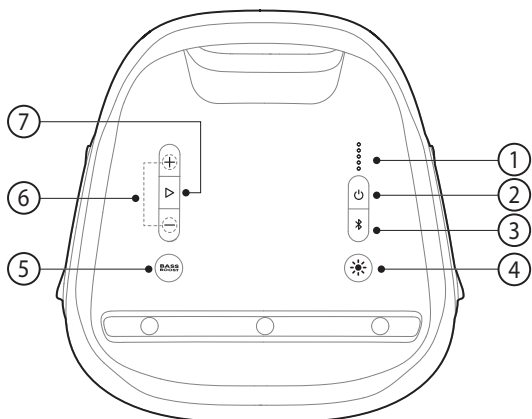

- 1) ○○○○○○
  - Battery level indicator.
- 2) ⏻
  - Press to power on or off.
- 3) 📶
  - Press to enter Bluetooth pairing mode.
  - Press and hold for 20 seconds to forget all the paired devices.
- 4) ☀️
  - Press to toggle between different light patterns.
  - Press and hold for 2 seconds to turn the strobe light on or off.
- 5) **BASS BOOST**
  - Press repeatedly to switch between bass boost level 1 and level 2 or turn off.
- 6) + / -
  - Press to increase or decrease the volume level.
  - Press both simultaneously to mute the audio output.
- 7) ▶
  - Press to play or pause the music.

#### Caution:

- Do not look directly at the light-emitting parts when the speaker lights are turned on.

### LED behavior

⏻	○ White (Constant)	Power on
	● Amber (Constant)	Standby
	● Off	Power off
📶	☀️ White White (Regular flash)	Pairing
	○ White (Constant)	Connected
	● Off	Not connected
<b>BASS BOOST</b>	○ White (Constant)	On
	● Off	Off
● ● ● ● ●	● Red (Slow flash)	Low battery
	○ White (Slow flash)	Charging
	○ White (Constant)	Charged

### 3.2 Back Panel

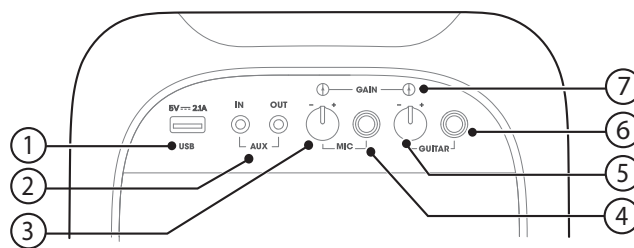

- 1) **USB**
  - Charge an external USB device.
  - Connect to a USB storage device.
- 2) **AUX**
  - Connect to an external audio device through an audio cable.
- 3) **VOLUME (MIC)**
  - Rotate the knob to adjust the microphone volume.
- 4) **MIC**
  - Connect to a microphone (not provided).
- 5) **VOLUME (GUITAR)**
  - Rotate the knob to adjust the guitar volume.
- 6) **GUITAR**
  - Connect to a guitar (not provided).
- 7) **GAIN**
  - Guitar and microphone gain control buttons to match different sensitivity of the mic and guitar.

---

## 4. POWER ON

### Cautions:

- Use only provided power cord.

Plug one of the end Ac power cord into the Power connector on the back speaker, then plug the other end to a wall outlet.

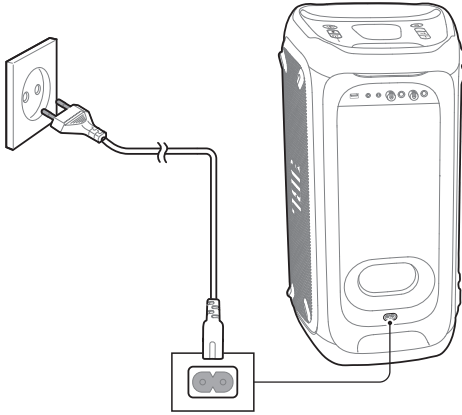

---

## 5. CHARGING

PartyBox is powered by a built-in rechargeable battery.

### Notes:

- Fully charge the built-in battery before using for the first time, which will prolong the battery lifespan.
- Built-in battery charging works on AC power only.

### 5.1 Charge your Speaker

Use the AC power to charge your PartyBox 100

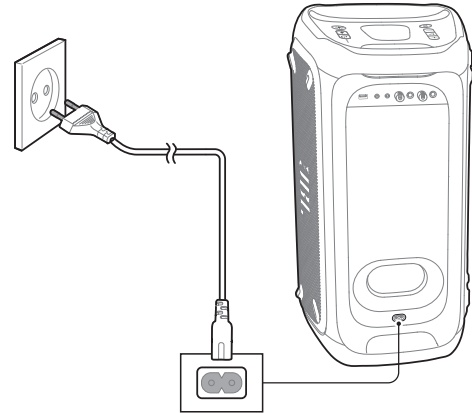

### 5.2 Check the Battery Level

The speaker is powered by the built-in rechargeable battery. After power-on, the speaker shows the battery level immediately, you can check the status of the PartyBox battery by pressing on any button.



## 6. USING YOUR PARTYBOX

### 6.1 Bluetooth connection

You can use your **PartyBox** as an external speaker for your Bluetooth enabled smartphone or tablet.

- 1) Press  to enter Bluetooth pairing mode.
- 2) Choose “**JBL PartyBox 100**” to connect.
- 3) Once successfully connected, audio will stream from your Bluetooth device to this speaker.

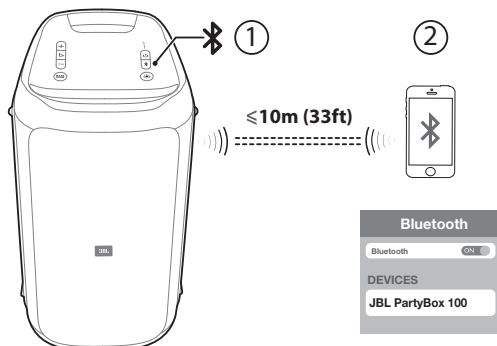

#### Notes:

- This speaker can memorize a maximum of 8 paired devices. The ninth paired device will replace the first one.
- If a PIN code is requested while connecting a Bluetooth device, enter “0000”.
- Bluetooth performance can be affected by the distance between this product and your Bluetooth device and the environment of operation.

#### To terminate the Bluetooth-enabled device:

- Turn off this speaker;
- Disable Bluetooth on your device; or
- Move this speaker beyond the Bluetooth operational range.

#### To reconnect the Bluetooth-enabled device:

- When you turn on this speaker next time, it tries to reconnect the last connected device automatically;
- If not, manually select “**JBL PartyBox 100**” on your Bluetooth device to start a connection.

#### Note:

- To exit Bluetooth mode, insert a USB storage device.

### 6.2 USB connection

With your **PartyBox**, you can enjoy music that is stored on a USB storage device such as an MP3 player.

Plug your USB storage device into the USB port of your **PartyBox**. The music will play automatically. If not, please check if the USB device contains playable audio contents.

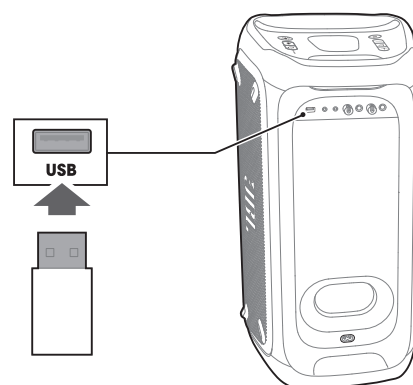

#### Audio formats

Extension	Codec	Sample rate	Bitrate
WAVE	PCM	8 / 11.025 / 12 / 16 / 22.05 / 24 / 32 / 44.1 / 48	384 / 529.2 / 576 / 768 / 1058.4 / 1152 / 1536 / 2116.8 / 2304
MP3	MPEG1 layer2/3	32 / 44.1 / 48	32 / 40 / 48 / 56 / 64 / 80 / 96 / 112 / 128 / 160 / 192 / 224 / 256 / 320
	MPEG2 layer2/3	16 / 22.05 / 24	8 / 16 / 24 / 32 / 40 / 48 / 56 / 64 / 80 / 96 / 112 / 128 / 144 / 160
	MPEG2.5 layer3	8 / 11.025 / 12	8 / 16 / 24 / 32 / 40 / 48 / 56 / 64 / 80 / 96 / 112 / 128 / 144 / 160
WMA		8 / 11.025 / 16 / 22.05 / 32 / 44.1/48	5 / 6 / 8 / 10 / 12 / 16 / 20 / 22 / 32 / 36 / 40 / 44 / 48 / 64 / 80 / 96 / 128 / 160 / 192 / 256 / 320

### 6.3 AUX connection

#### Notes:

- When the USB source is not playing, Bluetooth can break in and play music from the phone.
- When USB is playing, Bluetooth cannot break in USB.
- Priority goes to USB, Bluetooth and then Aux.

To play music on your portable audio device through this speaker, make sure that no Bluetooth connection or USB device is available.

- 1) Connect a 3.5mm audio cable (not supplied) to:
  - the headphone socket of your portable audio device;
  - the **AUX** connector of this speaker.

2) Turn on your portable audio device and it starts playing.

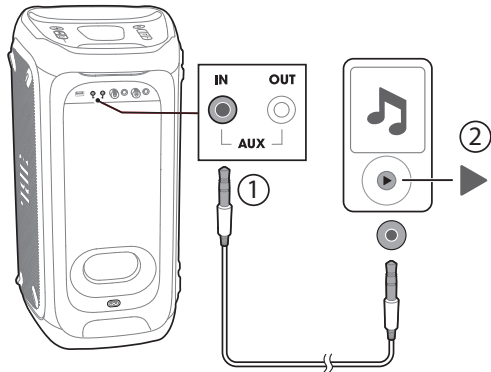

**Note:**

- To exit AUX mode, choose Bluetooth or USB as a source first

### 6.4 Mix Sound with a Microphone or Guitar

By using a microphone (not supplied) or an electric guitar (not supplied), you can mix its sound with an audio source.

- 1) Rotate counterclockwise the **MIC/GUITAR** volume knob to turn down the volume.
  - 2) Connect your microphone or guitar to the **MIC/GUITAR** jack of this speaker.
  - 3) Sing through the microphone or play guitar.
- To adjust the volume of the audio source, press **+** / **-**;
  - To adjust the volume of the microphone or guitar, rotate the **MIC/GUITAR** volume knob.

To adjust the echo mic level when the mic is plugged:

- Press **BASS BOOST** / **+** to toggle the echo level (echo level 1 set as default).
- Press **BASS BOOST** / **+** to switch from level 1 to level 2.
- Press **BASS BOOST** / **+** to turn off the echo level.

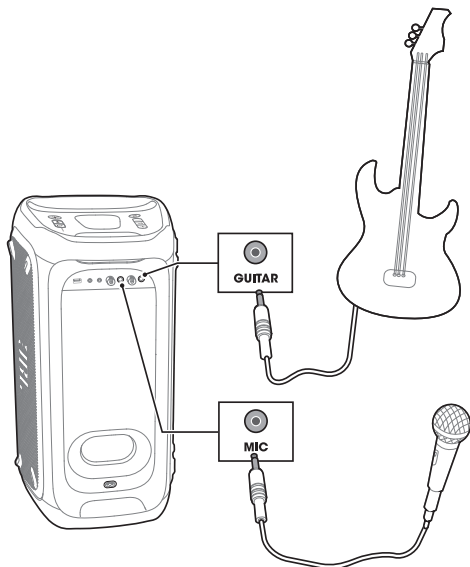

**Caution:**

- When not using the microphone or guitar, decrease the MIC/GUITAR volume to minimum and remove them from the jack.

### 6.5 Charging External USB Devices

You can use this speaker as a battery charger for your rechargeable USB devices.

Connect your USB device to the USB port on the rear of this speaker.

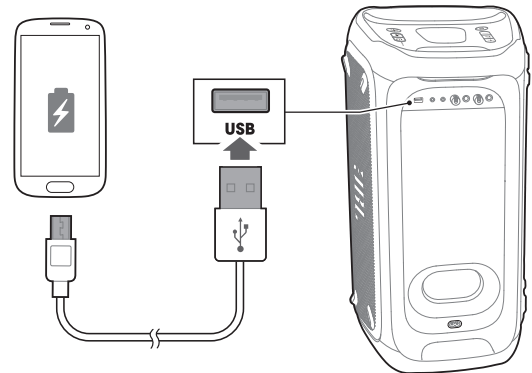

## 7. CARRYING YOUR PARTYBOX

### Cautions:

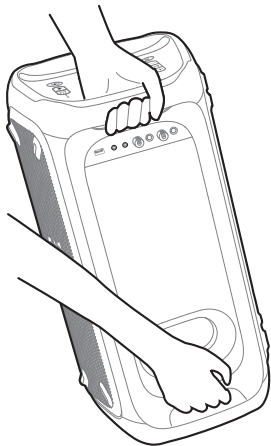

- Before carrying the speaker, make sure that all the cords are disconnected.
- To avoid personal injury and/or property damage, hold the product firmly while carrying.



## 8. SETTINGS

### 8.1 TWS Mode

The two **PartyBox 100** speakers can connect to each other in TWS mode.

- 1) Press and hold  on both speakers simultaneously for 5 seconds, you will hear a tone to indicate speakers are in pairing mode. Once TWS connection built up, you will hear another tone.
- 2) In TWS mode, press and hold  for 5 seconds on either speaker or power off the speaker to exit the TWS mode.

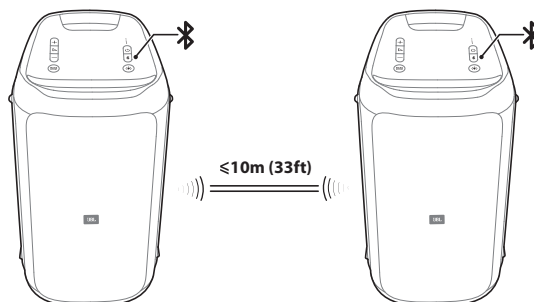



### 8.2 Demo Mode

#### Caution:

- Ensure PartyBox is powered by AC to go into Demo Mode.
- If the AC power unplugged, the PartyBox will power off. If the AC power is resumed the PartyBox will automatically enter to the demo mode.



To enter or to exit demo mode, press and hold  and **BASS BOOST** simultaneously for 5 seconds.

In demo mode, all the input sources are disabled, all buttons but  /  / **BASS BOOST** are disabled.

#### Note:

- The PartyBox built-in with 3 x 30 seconds music tracks.

#### Playback

- Press  once to start, pause or resume the play (one sample will be played only for 30 seconds).
- Press  once after the pause, to play the next track.

### 8.3 Standby Mode

The product will enter into sleep mode after 20 minutes without operation.

- If the “PartyBox” powered by the battery, it will auto power off if no action for 20 minutes.
- If the “PartyBox” powered by AC or DC power source, the product will enter standby mode if no action for 20 minutes.

Press  (power) or Bluetooth stream break-in in standby mode, the speaker will enter normal mode.

## 8.4 Speaker mounting

### a) Speaker Stand

Place the PartyBox on speaker stands (sold separately) for general-purpose sound reinforcement.

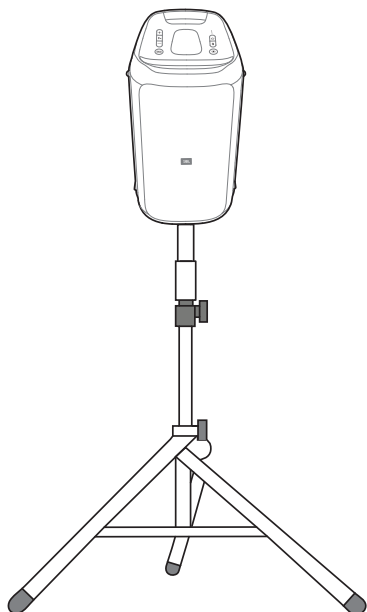

### b) Using a Speaker Stand

If you have purchased speaker stands, you can place the speakers on the stands utilizing the pole mount adaptor built into the PARTYBOX 100 speaker cabinets.

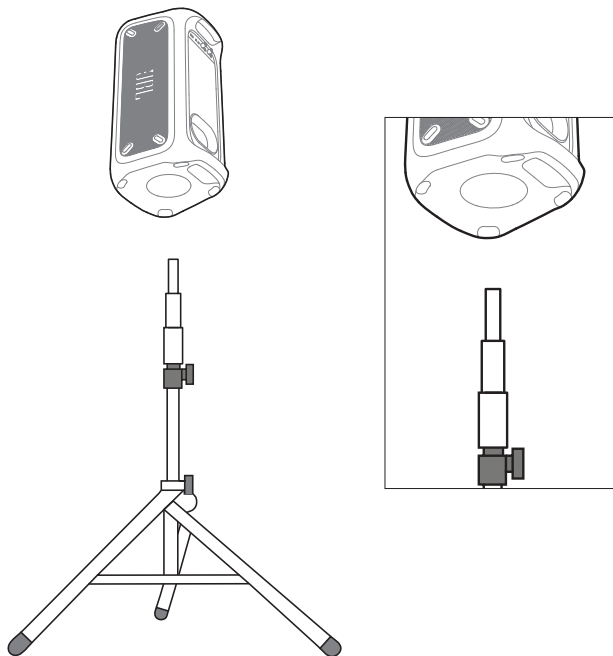

## 9. SPECIFICATIONS

- Product name: PartyBox 100
- AC power input: 100 - 240 V ~ 50/60 Hz
- Built-in battery: Li-ion 2500 mAh, 14.4 V
- Power consumption: 60 W
- Standby power consumption:
  - < 2 W with BT connecting;
  - < 0.5 W without BT connecting
- USB output: 5V  $\Rightarrow$  2.1A
- Speaker drivers: 2 woofers + 2 tweeters
- Speaker impedance: 4  $\Omega$
- Total output power: 160 W
- Signal-to-noise (S/N) ratio: 80 dBA
- Frequency response: 45 Hz - 18 KHz (-6 dB)
- Battery charge time: 5 hours
- Battery playtime: 12 hours\*
- Bluetooth version: 4.2
- Bluetooth profile: A2DP V1.3, AVRCP V1.6
- Bluetooth transmitter frequency range: 2402 - 2480 MHz
- Bluetooth maximum transmitter power: 15 dBm (EIRP)
- Bluetooth transmitter modulation: GFSK,  $\pi/4$  DQPSK, 8DPSK
- Bluetooth range: Approx. 10 m (33 ft)
- USB format: FAT16, FAT32
- USB file format: .mp3, .wma, .wav
- Input sensitivity (AUX in): 370 mV rms (3.5 mm connector)
- Digital input: Bluetooth/USB -9 dBFS
- Dimension (W x H x D): 288 x 551 x 290 mm /  
11.3 x 21.7 x 11.4 in
- Net weight: 9.7 kg / 21.4 lbs

\*12 hrs battery playtime is only for reference and may vary depending on music content and battery aging after numerous charging and discharging cycles. It's achievable with a predefined music source, light show switch off, volume level at 7 and BT streaming source.

## 10. TROUBLESHOOTINGS

### Caution:

- Never try to repair the product by yourself. If you have any problems while using this product, check the following points before you request service.

### System

The unit will not turn on.

- Check if the power cord is plugged into the outlet and to the **PartyBox**.
- Make sure the speaker is fully charged, if not use the power cord to turn on your speaker.

### Sound

No sound from the **PartyBox**.

- Make sure that the **PartyBox** is powered on.
- Make sure that volume level is turned to an audible level.
- Make sure that it is connected to a music source.

### Bluetooth

A device cannot connect with the **PartyBox**.

- Check if you enable the Bluetooth function of the device.
- The **PartyBox** is already connected to another Bluetooth device. Press and hold on Bluetooth to disconnect and pair with a new device.

Poor audio quality from a connected Bluetooth device.

- The Bluetooth reception is poor. Move the device closer to the **PartyBox**, or remove any obstacle between the device and the **PartyBox**.

## 11. COMPLIANCE

The product is in compliance with the European Union energy legislation.

### Bluetooth connection mode

The product is intended to be used for streaming music via Bluetooth connection. A consumer can stream Bluetooth audio to the speaker. When the product is connected through Bluetooth, the Bluetooth connection must remain active at all times to ensure proper operation.

The product will enter into sleep mode (networked standby), after 20 minutes without operation, the power consumption @ sleep is less than 2.0 Watts, after which it can be re-activated via Bluetooth connection.

### Bluetooth disconnection mode

The product will enter into standby mode, after 20 minutes without operation, the power consumption @ standby is less than 0.5 Watts.

---

## 12. TRADEMARK



Este equipamento não tem direito à proteção contra interferência prejudicial e não pode causar interferência em sistemas devidamente autorizados.

Este produto está homologado pela ANATEL, de acordo com os procedimentos regulamentados pela Resolução 242/2000, e atende aos requisitos técnicos aplicados.

Para maiores informações, consulte o site da ANATEL – [www.anatel.gov.br](http://www.anatel.gov.br)



The Bluetooth® word mark and logos are registered trademarks owned by the Bluetooth SIG, Inc. and any use of such marks by HARMAN International Industries, Incorporated is under license. Other trademarks and trade names are those of their respective owners.

Торговая марка	: JBL
Назначение товара	: Активная акустическая система
Изготовитель	: Харман Интернешнл Индастриз Инкорпорейтед, США, 06901 Коннектикут, г.Стэмфорд, Атлантик Стрит 400, офис 1500
Страна происхождения	: Китай
Импортер в Россию	: ООО "ХАРМАН РУС СиАйЭс", Россия, 127018, г.Москва, ул. Двинцев, д.12, к 1
Гарантийный период	: 1 год
Информация о сервисных центрах	: <a href="http://www.harman.com/ru">www.harman.com/ru</a> тел. +7-800-700-0467
Срок службы	: 5 лет

Товар сертифицирован



Дата производства : Дата изготовления устройства определяется по двум буквенным обозначениям из второй группы символов серийного номера изделия, следующих после разделительного знака «-». Кодировка соответствует порядку букв латинского алфавита, начиная с января 2010 года: 000000-MY0000000, где «M» - месяц производства (A - январь, B - февраль, C - март и т.д.) и «Y» - год производства (A - 2010, B - 2011, C - 2012 и т.д.).

Используйте устройство только по прямому назначению в соответствии с предоставленной инструкцией. Не пытайтесь самостоятельно вскрывать корпус товара и осуществлять ремонт. В случае обнаружения недостатков или дефектов, обращайтесь за гарантийным обслуживанием в соответствии с информацией из гарантийного талона. Особые условия хранения, реализации и (или) транспортировки не предусмотрены. Избегайте воздействия экстремальных температур, длительного воздействия влаги, сильных магнитных полей. Устройство предназначено для работы в жилых зонах. Срок годности не ограничен при соблюдении условий хранения.



HARMAN International Industries,  
Incorporated 8500 Balboa  
Boulevard, Northridge, CA 91329  
USA  
[www.jbl.com](http://www.jbl.com)

© 2019 HARMAN International Industries, Incorporated. All rights reserved. JBL is a trademark of HARMAN International Industries, Incorporated, registered in the United States and/or other countries. Features, specifications and appearance are subject to change without notice. The Bluetooth® word mark and logos are registered trademarks owned by Bluetooth SIG, Inc. and any use of such marks by HARMAN International Industries, Incorporated is under license. Other trademarks and trade names are those of their respective owners. The terms HDMI, the HDMI logo, and High-Definition Multimedia Interface are trademarks or registered trademarks of HDMI Licensing LLC in the United States and other countries. Manufactured under license from Dolby Laboratories. Dolby, Dolby Audio, Pro Logic and the double-D symbol are trademarks of Dolby Laboratories.